

Article number: 03554090

Description: Fluro hydraulic rod end FMA 90D

Measures

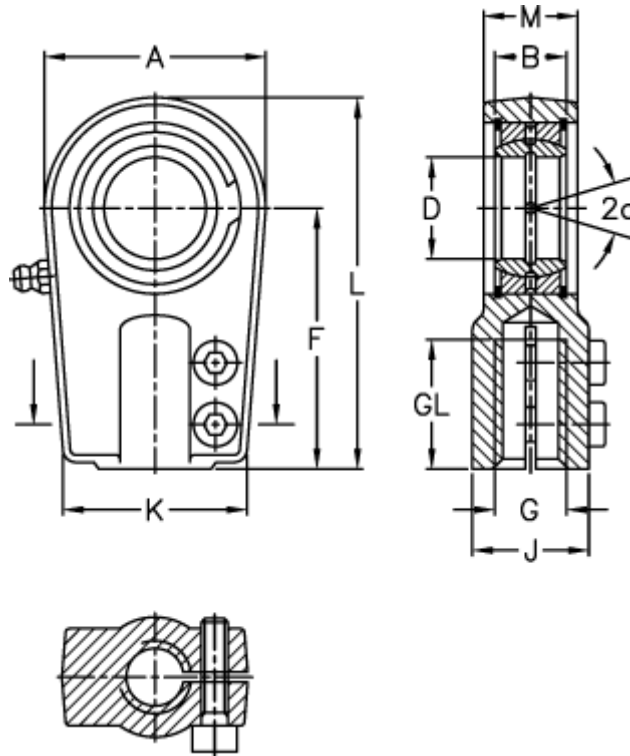

A	= 206	J	= 150
a (degrees)	= 5	K	= 162
B	= 60	L	= 363
D	= 90	M	= 65
Dynamic load C (kN)	= 695	Static load C0 (kN)	= 1330
F	= 250	Torque (N m)	= 300
g	= M100x3	Weight	= 28000
GL	= 140		